

HFA16TA60C

HEXFRED™

Ultrafast, Soft Recovery Diode

Features

- Ultrafast Recovery
- Ultrasoft Recovery
- Very Low I_{RRM}
- Very Low Q_{rr}
- Specified at Operating Conditions

Benefits

- Reduced RFI and EMI
- Reduced Power Loss in Diode and Switching Transistor
- Higher Frequency Operation
- Reduced Snubbing
- Reduced Parts Count

Description

International Rectifier's HFA16TA60C is a state of the art center tap ultra fast recovery diode. Employing the latest in epitaxial construction and advanced processing techniques it features a superb combination of characteristics which result in performance which is unsurpassed by any rectifier previously available. With basic ratings of 600 volts and 15 amps per Leg continuous current, the HFA16TA60C is especially well suited for use as the companion diode for IGBTs and MOSFETs. In addition to ultra fast recovery time, the HEXFRED product line features extremely low values of peak recovery current (I_{RRM}) and does not exhibit any tendency to "snap-off" during the t_b portion of recovery. The HEXFRED features combine to offer designers a rectifier with lower noise and significantly lower switching losses in both the diode and the switching transistor. These HEXFRED advantages can help to significantly reduce snubbing, component count and heatsink sizes. The HEXFRED HFA16TA60C is ideally suited for applications in power supplies and power conversion systems (such as inverters), motor drives, and many other similar applications where high speed, high efficiency is needed.

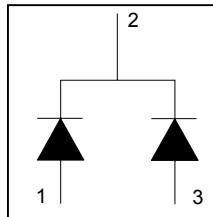

$V_R = 600V$
 $V_F(\text{typ.})^* = 1.7V$
 $Q_{rr}^* = 65nC$
 $di_{(rec)M}/dt^* = 240A/\mu s$
 $*125^\circ C$

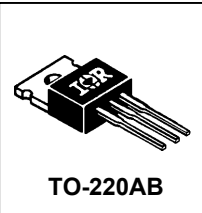

Absolute Maximum Ratings (per Leg)

	Parameter	Max	Units
V_R	Cathode-to-Anode Voltage	600	V
$I_F @ T_C = 100^\circ C$	Continuous Forward Current	8.0	A
I_{FSM}	Single Pulse Forward Current	60	
I_{FRM}	Maximum Repetitive Forward Current	24	
$P_D @ T_C = 25^\circ C$	Maximum Power Dissipation	36	C
$P_D @ T_C = 100^\circ C$	Maximum Power Dissipation	14	
T_J	Operating Junction and	-55 to +150	W
T_{STG}	Storage Temperature Range		

Electrical Characteristics (per Leg) @ T_J = 25°C (unless otherwise specified)

	Parameter	Min	Typ	Max	Units	Test Conditions	
V _{BR}	Cathode Anode Breakdown Voltage	600			V	I _R = 100μA	
V _{FM}	Max Forward Voltage		1.4	1.7	V	I _F = 8A	
			1.7	2.1		I _F = 16A	See Fig. 1
			1.4	1.7		I _F = 8A, T _J = 125°C	
I _{RM}	Max Reverse Leakage Current		0.3	5	μA	V _R = V _R Rated	
			100	500		T _J = 125°C, V _R = 0.8 x V _R Rated	See Fig. 2
C _T	Junction Capacitance		10	25	pF	V _R = 200V	
L _S	Series Inductance		8.0		nH	Measured lead to lead 5mm from package body	

Dynamic Recovery Characteristics (per Leg) @ T_J = 25°C (unless otherwise specified)

	Parameter	Min	Typ	Max	Units	Test Conditions	
t _{rr}	Reverse Recovery Time		18		ns	I _F = 1.0A, di _F /dt = 200A/μs, V _R = 30V T _J = 25°C	
t _{rr1}	See Fig. 5, 10		37	55			T _J = 125°C
t _{rr2}			55	90			T _J = 25°C
I _{RRM1}	Peak Recovery Current		3.5	5.0	A	I _F = 8A V _R = 200V	
			4.5	8			T _J = 125°C
I _{RRM2}	See Fig. 6						
Q _{rr1}	Reverse Recovery Charge		65	138	nC	T _J = 25°C	
Q _{rr2}		See Fig. 7		124			360
di _{(rec)M} /dt1	Peak Rate of Fall of Recovery Current		240		A/μs	T _J = 25°C	
di _{(rec)M} /dt2		During t _b See Fig. 8		210			

Thermal - Mechanical Characteristics (per Leg)

	Parameter	Min	Typ	Max	Units
T _{lead} ①	Lead Temperature			300	°C
R _{thJC}	Junction-to-Case, Single Leg Conducting			3.5	K/W
	Junction-to-Case, Both Legs Conducting			1.75	
R _{thJA} ②	Thermal Resistance, Junction to Ambient			80	
R _{thCS} ③	Thermal Resistance, Case to Heat Sink		0.5		
Wt	Weight		2.0		g
				0.07	(oz)
	Mounting Torque		6.0	12	Kg-cm
			5.0	10	lbf-in

① 0.063 in. from Case (1.6mm) for 10 sec

② Typical Socket Mount

③ Mounting Surface, Flat, Smooth and Greased

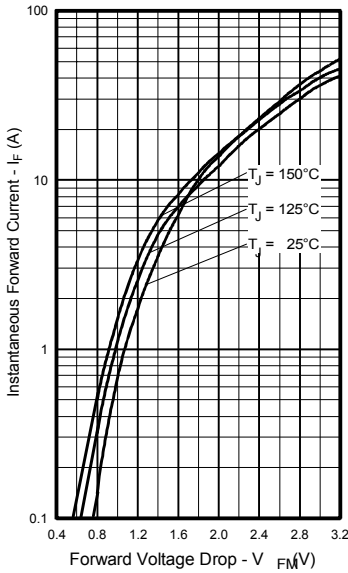

Fig. 1 - Maximum Forward Voltage Drop vs. Instantaneous Forward Current, (per Leg)

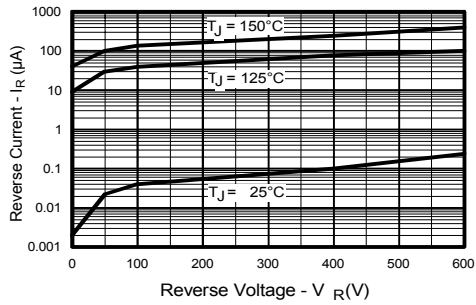

Fig. 2 - Typical Reverse Current vs. Reverse Voltage, (per Leg)

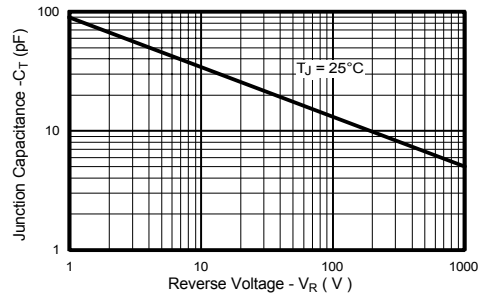

Fig. 3 - Typical Junction Capacitance vs. Reverse Voltage, (per Leg)

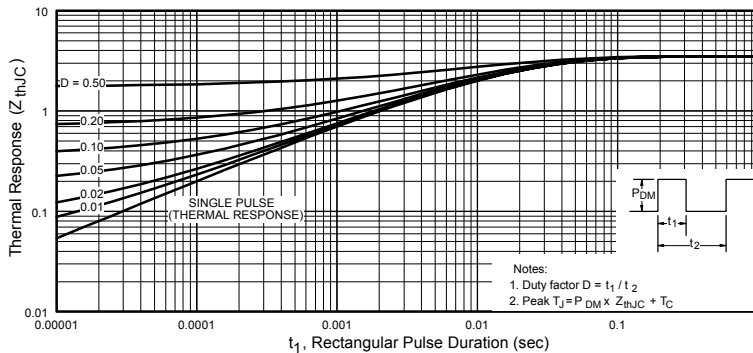

Fig. 4 - Maximum Thermal Impedance Z_{thjC} Characteristics, (per Leg)

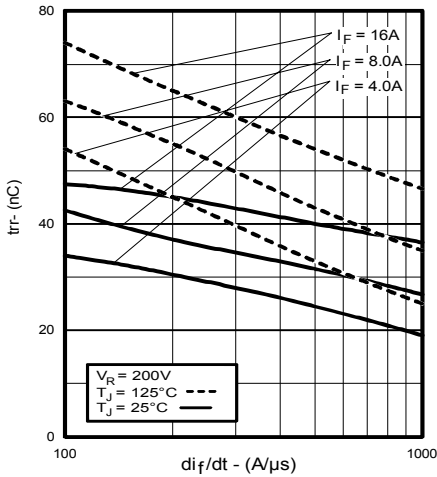

Fig. 5 - Typical Reverse Recovery vs. di_f/dt , (per Leg)

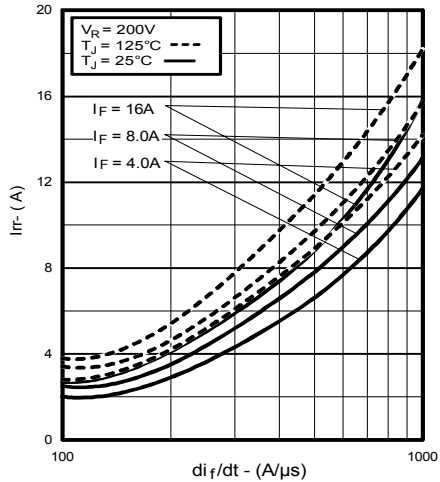

Fig. 6 - Typical Recovery Current vs. di_f/dt , (per Leg)

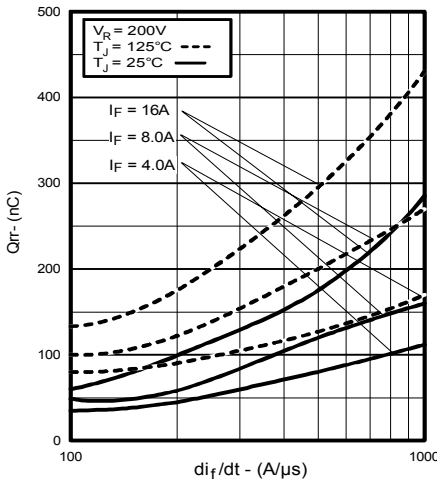

Fig. 7 - Typical Stored Charge vs. di_f/dt , (per Leg)

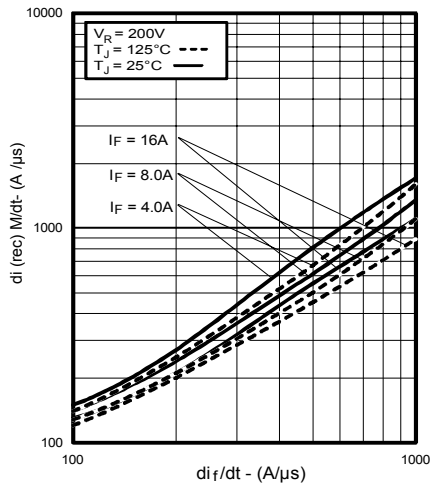

Fig. 8 - Typical $di_{(rec)M}/dt$ vs. di_f/dt , (per Leg)

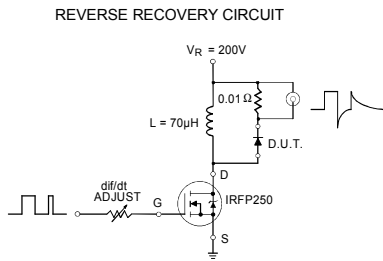

Fig. 9 - Reverse Recovery Parameter Test Circuit

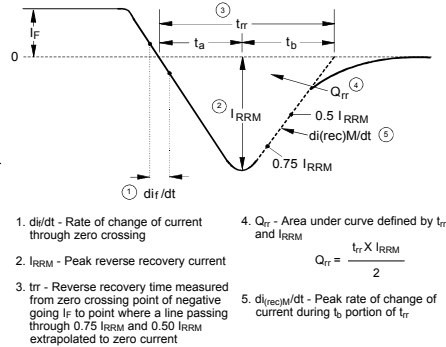
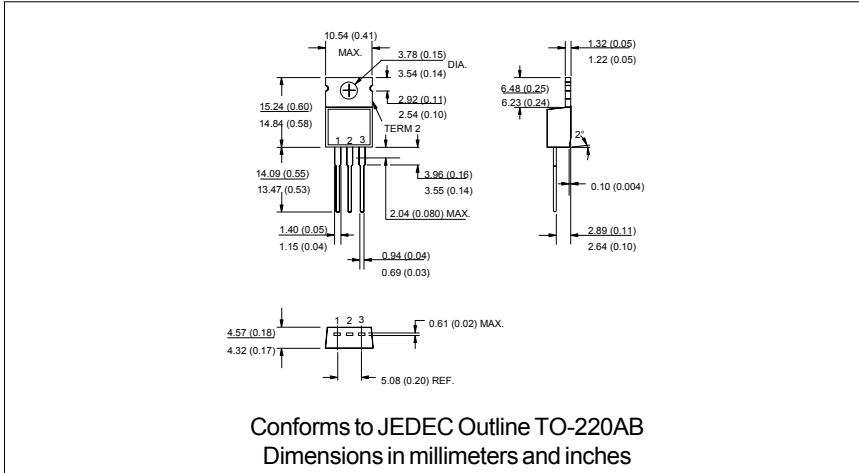

Fig. 10 - Reverse Recovery Waveform and Definitions

HFA16TA60C

Bulletin PD-2.342 rev. A 11/00

International
IRF Rectifier



International
IRF Rectifier

WORLD HEADQUARTERS: 233 Kansas St., El Segundo, California 90245 U.S.A. Tel: (310) 322 3331. Fax: (310) 322 3332.
EUROPEAN HEADQUARTERS: Hurst Green, Oxted, Surrey RH8 9BB, U.K. Tel: +44 1883 732020. Fax: +44 1883 733408.
IR CANADA: 15 Lincoln Court, Brampton, Markham, Ontario L6T3Z2. Tel: (905) 453 2200. Fax: (905) 475 8801.
IR GERMANY: Saalburgstrasse 157, 61350 Bad Homburg. Tel: +49 6172 96590. Fax: +49 6172 965933.
IR ITALY: Via Liguria 49, 10071 Borgaro, Torino. Tel: +39 11 4510111. Fax: +39 11 4510220.
IR FAR EAST: K&H Bldg., 2F, 30-4 Nishi-Ikebukuro 3-Chome, Toshima-Ku, Tokyo, Japan 171. Tel: 81 3 3983 0086.
IR SOUTHEAST ASIA: 1 Kim Seng Promenade, Great World City West Tower, 13-11, Singapore 237994. Tel: +65 838 4630.
IR TAIWAN: 16 Fl. Suite D.207, Sec. 2, Tun Haw South Road, Taipei, 10673, Taiwan. Tel: 886 2 2377 9936.

<http://www.irf.com>

Fax-On-Demand: +44 1883 733420

Data and specifications subject to change without notice.